



Design Example Report

Title	<i>7.3 W Dual Output Non-Isolated Power Supply using TNY266P</i>
Specification	Input: 90 – 265 VAC Output: 5V / 500mA, 24V / 200mA
Application	Cook Top Control
Author	Power Integrations Applications Department
Document Number	DER-110
Date	October 26, 2005
Revision	1.0

Summary and Features

- Compact 1.5" X 2" X 1" PCB footprint
- Total output power 6.0 W with TNY266P and EE16 core
- Typical Efficiency 75 %
- Good cross regulation using low-cost zener
- Meets EN55022 class B conducted EMI test without Y1 safety capacitor
- No Optocoupler used in the feedback loop

The products and applications illustrated herein (including circuits external to the products and transformer construction) may be covered by one or more U.S. and foreign patents or potentially by pending U.S. and foreign patent applications assigned to Power Integrations. A complete list of Power Integrations' patents may be found at www.powerint.com.

Table Of Contents

1	Introduction.....	3
2	Power Supply Specification	4
3	Schematic.....	5
4	PCB Layout	6
5	Bill Of Materials.....	7
6	Transformer Specification.....	8
6.1	Electrical Diagram	8
6.2	Electrical Specifications	8
6.3	Materials.....	8
6.4	Transformer Build Diagram	9
6.5	Transformer Construction.....	9
7	Transformer Spreadsheets	10
8	Performance Data.....	13
8.1	Efficiency	13
8.2	No-load Input Power	14
8.3	Regulation	15
8.3.1	Load	15
8.3.2	Line	16
9	Waveforms	17
9.1	Drain Voltage and Current, Normal Operation.....	17
9.2	Output Voltage Start-up Profile.....	17
9.3	Drain Voltage and Current Start-up Profile	18
9.4	Load Transient Response (50% to 100% Load Step).....	18
9.5	Output Ripple Measurements.....	19
9.5.1	Ripple Measurement Technique.....	19
9.5.2	Measurement Results	20
10	Conducted EMI	21
11	Revision History	22

Important Notes:

Although this board is designed to satisfy safety isolation requirements, the engineering prototype has not been agency approved. Therefore, all testing should be performed using an isolated source to provide power to the prototype board.

Design Reports contain a power supply design specification, schematic, bill of materials, and transformer documentation. Performance data and typical operation characteristics are included. Typically only a single prototype has been built.



1 Introduction

This document is an engineering report describing a dual output non-isolated power supply utilizing a TNY266P. This power supply is intended as a power supply for a cooktop control module.

The document contains the power supply specification, schematic, bill-of-materials, transformer documentation, printed circuit layout, and performance data.

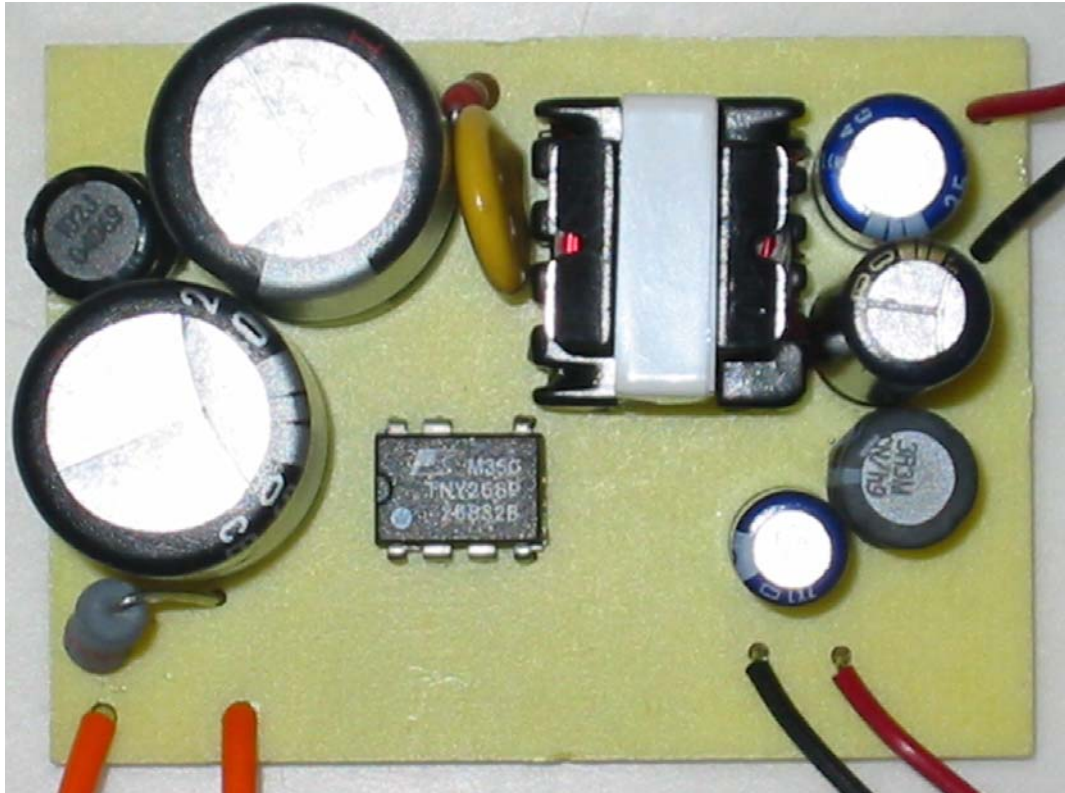

Figure 1 – Populated Circuit Board Photograph



2 Power Supply Specification

Description	Symbol	Min	Typ	Max	Units	Comment
Input						
Voltage	V_{IN}	90		265	VAC	2 Wire – no P.E.
Frequency	f_{LINE}	47	50/60	64	Hz	
No-load Input Power (230 VAC)				0.7	W	
Output						
Output Voltage 1	V_{OUT1}		5		V	± 5% 20 MHz bandwidth
Output Ripple Voltage 1	$V_{RIPPLE1}$		50		mV	
Output Current 1	I_{OUT1}		500		mA	
Output Voltage 2	V_{OUT1}		24		V	± 15% 20 MHz bandwidth
Output Ripple Voltage 2	$V_{RIPPLE1}$		200		mV	
Output Current 2	I_{OUT1}		200		mA	
Output Power	P_{OUT}		7.3		W	
Efficiency	η	80			%	Measured at P_{OUT} (7.3 W), 25 °C
Environmental						
Conducted EMI			Meets CISPR22B / EN55022B			
Safety			Designed to meet IEC950, UL1950 Class II			
Surge		4			kV	1.2/50 μ s surge, IEC 1000-4-5, Series Impedance: Differential Mode: 2 Ω Common Mode: 12 Ω
Surge		3			kV	100 kHz ring wave, 500 A short circuit current, differential and common mode
Ambient Temperature	T_{AMB}	0		70	°C	Free convection, sea level



3 Schematic

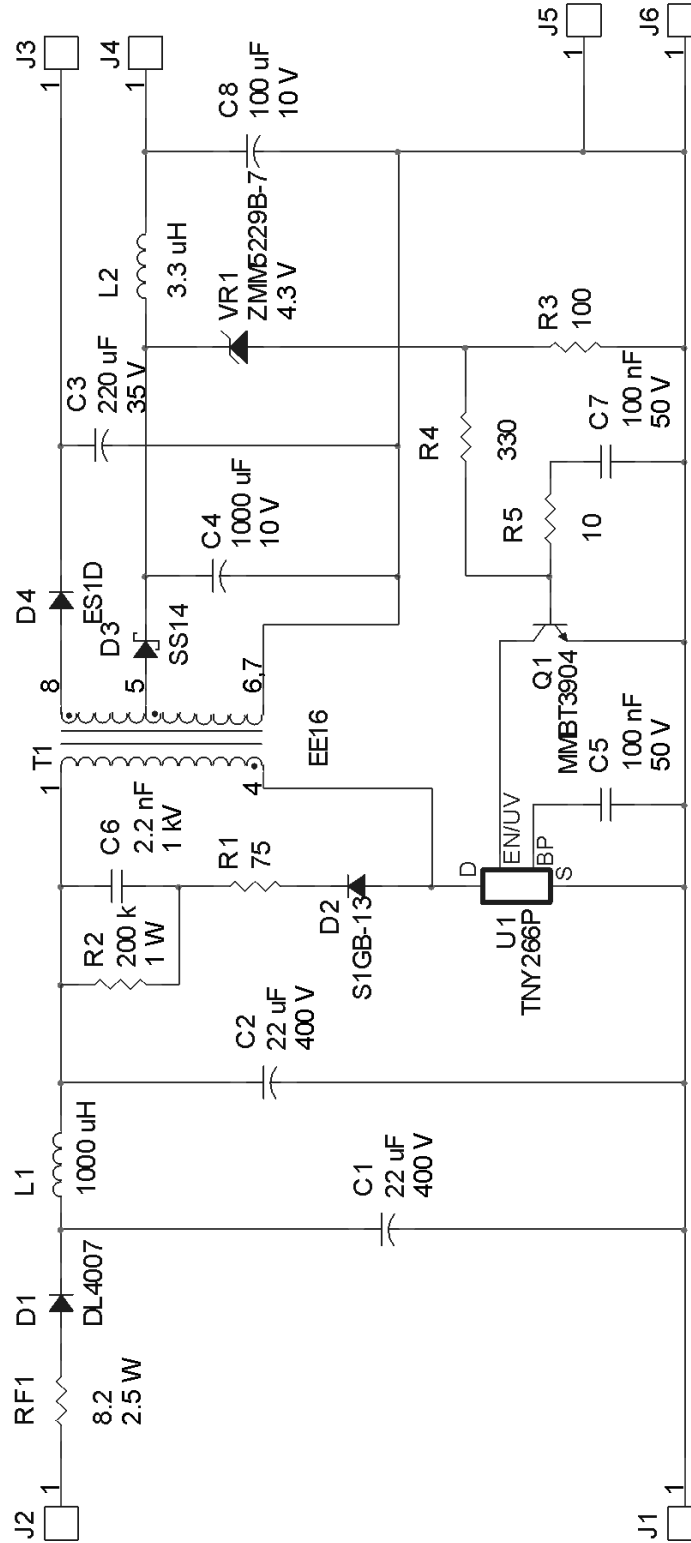

Figure 2 – Schematic



4 PCB Layout

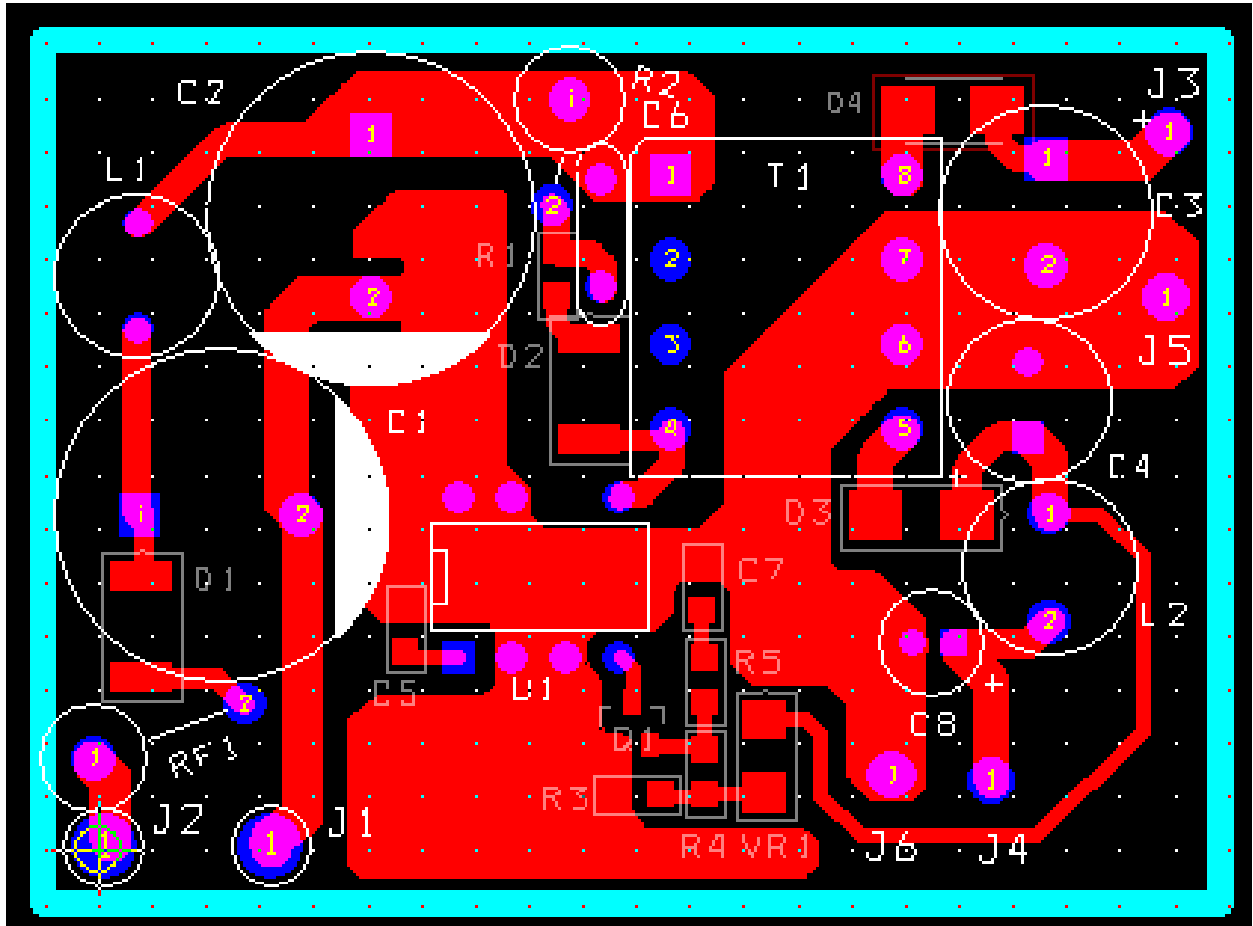

Figure 3 – Printed Circuit Layout



5 Bill Of Materials

Item	QTY	Ref. Des.	Description	Mfg	Mfg Part Number
1	2	C1 C2	22 uF, 400 V, Electrolytic, Low ESR, 901 mOhm, (16 x 20)	United Chemi-Con	KMX400VB22RM16X20LL
2	1	C3	330 uF, 35 V, Electrolytic, Very Low ESR, 38 mOhm, (10 x 16)	United Chemi-Con	KZE35VB331MJ16LL
3	1	C4	1000 uF, 10 V, Electrolytic, Low ESR, 80 mOhm, (8 x 20)	United Chemi-Con	LXZ10VB102MH20LL
4	2	C5 C7	100 nF, 50 V, Ceramic, X7R, 0805	Panasonic	ECU-V1H221KBN
5	1	C6	2.2 nF, 1 kV, Disc Ceramic	NIC Components Corp	NCD222K1KVY5F
6	1	C8	100 uF, 10 V, Electrolytic, Low ESR, 500 mOhm, (5 x 11.5)	United Chemi-Con	LXZ10VB101ME11LL
7	1	D1	1000 V, 1 A, Rectifier, Glass Passivated, DO-213AA (MELF)	Diodes Inc	DL4007
8	1	D2	400 V, 1 A, Rectifier, Glass Passivated	Diodes Inc	S1GB-13
9	1	D3	40 V, 1 A, Schottky, DO-214AC	Vishay	SS14
10	1	D4	200 V, 1 A, Ultrafast Recovery, 25 ns, DO-214AC	Vishay	ES1C
11	1	L1	1000 uH, 0.29 A	Tokin	SBC4-102-291
12	1	L2	3.3 uH, 2.66 A	Toko	822LY-3R3M
13	1	Q1	NPN, Small Signal BJT, 40 V, 0.2 A, SOT-23	Vishay	MMBT3904
14	1	R1	75 R, 5%, 1/8 W, Metal Film, 0805	Panasonic	ERJ-6GEYJ750V
15	1	R2	200 k, 5%, 1 W, Metal Oxide	Yageo	RSF100JB-200K
16	1	R3	100 R, 5%, 1/8 W, Metal Film, 0805	Panasonic	ERJ-6GEYJ101V
17	1	R4	330 R, 5%, 1/8 W, Metal Film, 0805	Panasonic	ERJ-6GEYJ331V
18	1	R5	10 R, 5%, 1/8 W, Metal Film, 0805	Panasonic	ERJ-6GEYJ100V
19	1	RF1	8.2 R, 2.5 W, Fusible/Flame Proof Wire Wound	Vitrohm	CRF253-4 5T 8R2
20	1	T1	Bobbin, EE16, Vertical, 8 pins	Bu Chang Ind Co Ltd	
21	1	U1	TinySwitch-II, TNY266P, DIP-8B	Power Integrations	TNY266P
22	1	VR1	4.3 V, 5%, 500 mW, DO-213AA (MELF)	Diodes Inc	ZMM5229B-7



6 Transformer Specification

6.1 Electrical Diagram

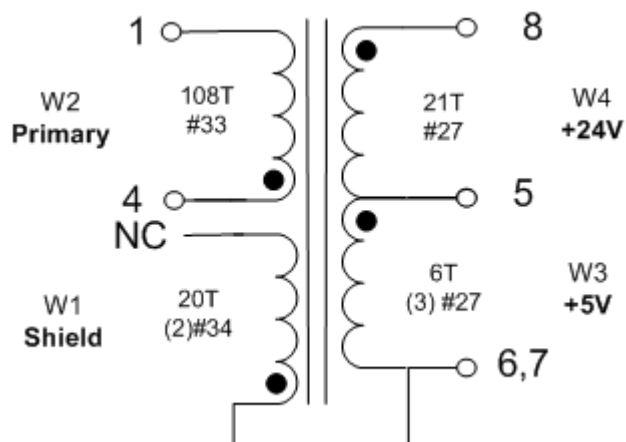

Figure 4 – Transformer Electrical Diagram

6.2 Electrical Specifications

Electrical Strength	1 second, 60 Hz, from Pins 1-4 to Pins 5-10	200 VAC
Primary Inductance	Pins 1-4, all other windings open, measured at 100 kHz, 0.4 VRMS	1570 μ H, -0/+20%
Resonant Frequency	Pins 1-4, all other windings open	800 kHz (Min.)
Primary Leakage Inductance	Pins 1-4, with Pins 5-10 shorted, measured at 100 kHz, 0.4 VRMS	60 μ H (Max.)

6.3 Materials

Item	Description
[1]	Core: EE16 PC40 Al = 124nH/T ²
[2]	Bobbin: 10-pin Vertical
[3]	Magnet Wire: #34 Heavy Build
[4]	Magnet Wire: #33 Heavy Build
[5]	Magnet Wire: #27 Heavy Build
[6]	Tape, 3M
[7]	Varnish



6.4 Transformer Build Diagram

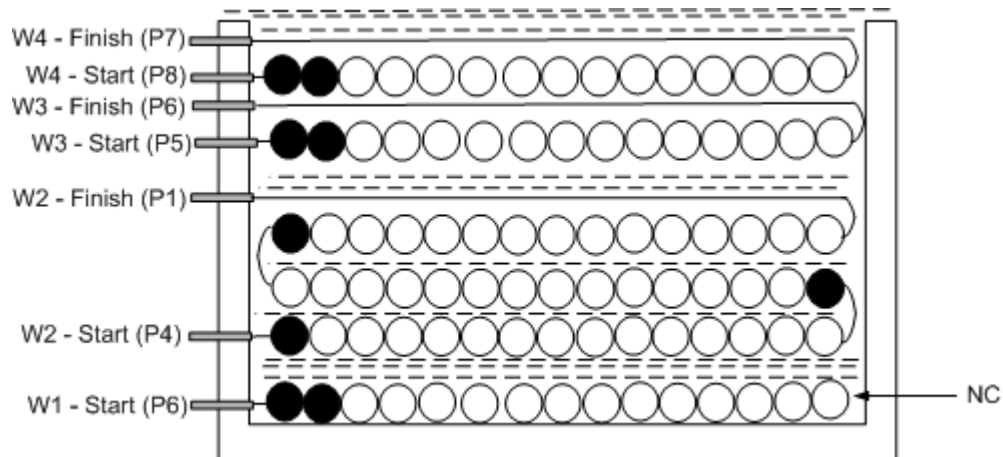

Figure 5 – Transformer Build Diagram

6.5 Transformer Construction

Core Shield	Start at pin 6 and wind 20 turns of bifilar wound #34. Do not connect finish end of this winding.
Basic Insulation	Apply three layers of tape for basic insulation.
Primary	Start on pin 4, wind 108 turns of #33 in three layers. Apply one layer of tape between each adjacent winding layer.
Basic Insulation	Apply two layers of tape for basic insulation.
Secondary Winding	Start on pin 5, wind 6 turns of trifilar #27 in one layer. Finish on pin 6.
Secondary Winding	Start on pin 8, wind 21 turns of #27 in one layer. Finish on pin 5.
Outer Wrap	Wrap windings with 3 layers of tape.
Final Assembly	Assemble and secure core halves. Dip varnish, do not impregnate (item [7]).



7 Transformer Spreadsheets

ACDC_TNY-
II_020105;
Rev.2.4;
Copyright
Power
Integrations
Inc. 2005

ACDC_TNYII_020105_Rev2-4.xls; TinySwitch-II
Continuous/Discontinuous Flyback Transformer
Design Spreadsheet

ENTER APPLICATION VARIABLE S

INPUT	INFO	OUTPUT	UNIT	
VACMIN	85		Volts	Minimum AC Input Voltage
VACMAX	265		Volts	Maximum AC Input Voltage
fL	50		Hertz	AC Mains Frequency
VO	5		Volts	Output Voltage
PO	7.3		Watts	Output Power
n	0.7			Efficiency Estimate
Z		0.5		Loss Allocation Factor
tC			mSec	
			3 onds	Bridge Rectifier Conduction Time Estimate
CIN	20		uFara ds	Input Filter Capacitor

Customer

ENTER TinySwitch-II VARIABLES

TinySwitch-II	Value	Unit	Description
	tny266		
		Univer sal	115 Doubled/230V
		Power	
Chosen Device	TNY266	Out	9.5W 15W
ILIMITMIN		0.325Amps	TinySwitch-II Minimum Current Limit
ILIMITMAX		0.375Amps	TinySwitch-II Maximum Current Limit
fS		132000Hertz	TinySwitch-II Switching Frequency
fSmin		120000Hertz	TinySwitch-II Minimum Switching Frequency (inc. jitter)
fSmax		144000Hertz	TinySwitch-II Maximum Switching Frequency (inc. jitter)
VOR	99	Volts	Reflected Output Voltage
VDS		10 Volts	TinySwitch-II on-state Drain to Source Voltage
VD	0.5	Volts	Output Winding Diode Forward Voltage Drop
			Ripple to Peak Current Ratio (0.6<KRP<1.0 :
KP		0.67	1.0<KDP<6.0)

ENTER TRANSFORMER CORE/CONSTRUCTION VARIABLES

Core Type	Value	P/N:	Description
Core	EE16	PC40EE16-Z	
	EE16_B		
Bobbin	OBBIN	BE-16-118CPH	
AE		0.192 cm^2	Core Effective Cross Sectional Area
LE		3.5 cm	Core Effective Path Length
AL		1140 nH/T^A	Ungapped Core Effective Inductance



BW		2	8.5 mm	Bobbin Physical Winding Width
M	0		mm	Safety Margin Width (Half the Primary to Secondary Creepage Distance)
L	3			Number of Primary Layers
NS	6			Number of Secondary Turns

DC INPUT VOLTAGE PARAMETERS

VMIN		85 Volts	Minimum DC Input Voltage
VMAX		375 Volts	Maximum DC Input Voltage

CURRENT WAVEFORM SHAPE PARAMETERS

DMAX	0.57	Maximum Duty Cycle
I AVG	0.12 Amps	Average Primary Current
IP	0.33 Amps	Minimum Peak Primary Current
IR	0.22 Amps	Primary Ripple Current
IRMS	0.17 Amps	Primary RMS Current

TRANSFORMER PRIMARY DESIGN PARAMETERS

LP	1570 uH	Primary Inductance
NP	108	Primary Winding Number of Turns
ALG	$\frac{nH}{T^2}$ 1352	Gapped Core Effective Inductance
BM	2840 Gauss	Maximum Flux Density, (BP < 3100) AC Flux Density for Core Loss Curves (0.5 X Peak to Peak)
BAC	824 Gauss	Relative Permeability of Ungapped Core
ur	1654	Gap Length (Lg > 0.1 mm)
LG	0.16 mm	Effective Bobbin Width
BWE	25.5 mm	Maximum Primary Wire Diameter including insulation
OD	0.24 mm	Estimated Total Insulation Thickness (= 2 * film thickness)
INS	0.05 mm	Bare conductor diameter
DIA	0.19 mm	Primary Wire Gauge (Rounded to next smaller standard AWG value)
AWG	33 AWG	Bare conductor effective area in circular mils
CM	51 Cmil	Primary Winding Current Capacity (200 < CMA < 500)
CMA	$\frac{Cmil}{Amp}$ 299 Amp	

TRANSFORMER SECONDARY DESIGN PARAMETERS

Lumped parameters

ISP	5.85 Amps	Peak Secondary Current
ISRMS	2.66 Amps	Secondary RMS Current
IO	1.46 Amps	Power Supply Output Current
IRIPPLE	2.22 Amps	Output Capacitor RMS Ripple Current
CMS	531 Cmil	Secondary Bare Conductor minimum circular mils
AWGS	22 AWG	Secondary Wire Gauge (Rounded up to next larger)



DIAS	0.65 mm	standard AWG value) Secondary Minimum Bare Conductor Diameter
ODS	1.42 mm	Secondary Maximum Outside Diameter for Triple Insulated Wire
INSS	0.39 mm	Maximum Secondary Insulation Wall Thickness

VOLTAGE STRESS PARAMETERS

VDRAIN	603 Volts	Maximum Drain Voltage Estimate (Includes Effect of Leakage Inductance)
PIVS	26 Volts	Output Rectifier Maximum Peak Inverse Voltage

TRANSFORMER SECONDARY DESIGN PARAMETERS (MULTIPLE OUTPUTS)

1st output

VO1	5	5 Volts	Output Voltage (if unused, defaults to single output design)
IO1	0.5	0.500 Amps	Output DC Current
PO1		2.50 Watts	Output Power
VD1	0.5	0.5 Volts	Output Diode Forward Voltage Drop
NS1		6.00	Output Winding Number of Turns
ISRMS1		0.910 Amps	Output Winding RMS Current
IRIPPLE1		0.76 Amps	Output Capacitor RMS Ripple Current
PIVS1		26 Volts	Output Rectifier Maximum Peak Inverse Voltage
CMS1		182 Cmil	Output Winding Bare Conductor minimum circular mils Wire Gauge (Rounded up to next larger standard AWG value)
AWGS1		27 AWG	
DIAS1		0.36 mm	Minimum Bare Conductor Diameter
ODS1		1.42 mm	Maximum Outside Diameter for Triple Insulated Wire

2nd output

VO2	24	Volts	Output Voltage
IO2	0.2	Amps	Output DC Current
PO2		4.80 Watts	Output Power
VD2	0.6	Volts	Output Diode Forward Voltage Drop
NS2		26.84	Output Winding Number of Turns
ISRMS2		0.364 Amps	Output Winding RMS Current
IRIPPLE2		0.30 Amps	Output Capacitor RMS Ripple Current
PIVS2		117 Volts	Output Rectifier Maximum Peak Inverse Voltage
CMS2		73 Cmil	Output Winding Bare Conductor minimum circular mils Wire Gauge (Rounded up to next larger standard AWG value)
AWGS2		31 AWG	
DIAS2		0.23 mm	Minimum Bare Conductor Diameter
ODS2		0.32 mm	Maximum Outside Diameter for Triple Insulated Wire



8 Performance Data

All measurements performed at room temperature, 60 Hz input frequency.

8.1 Efficiency

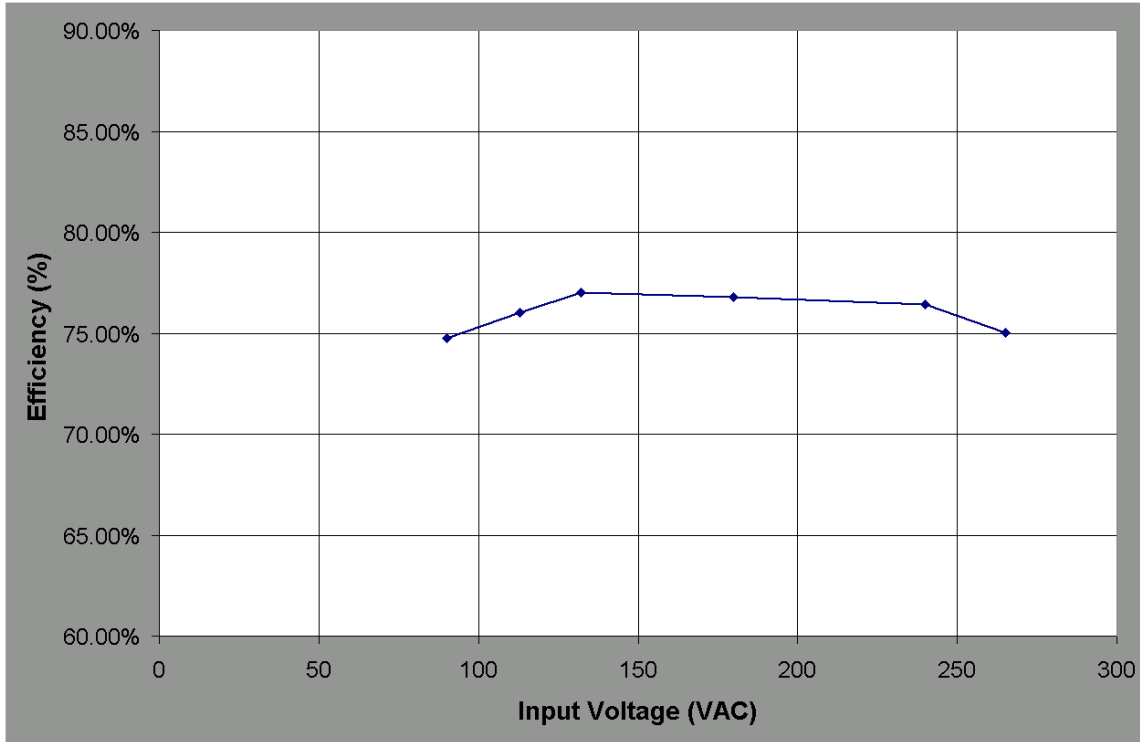

Figure 6 – Efficiency at Full Load vs. Input Voltage, Room Temperature, 60 Hz.



8.2 No-load Input Power

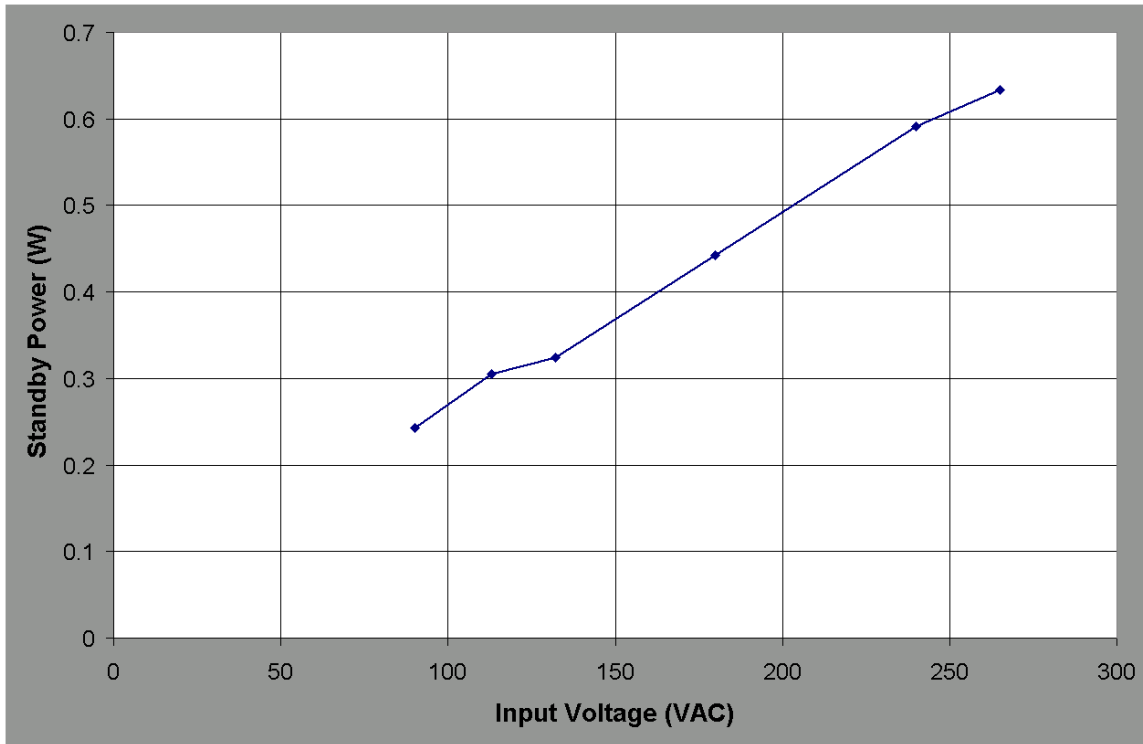

Figure 7 – Zero Load Input Power vs. Input Line Voltage, Room Temperature, 60 Hz.



8.3 Regulation

8.3.1 Load

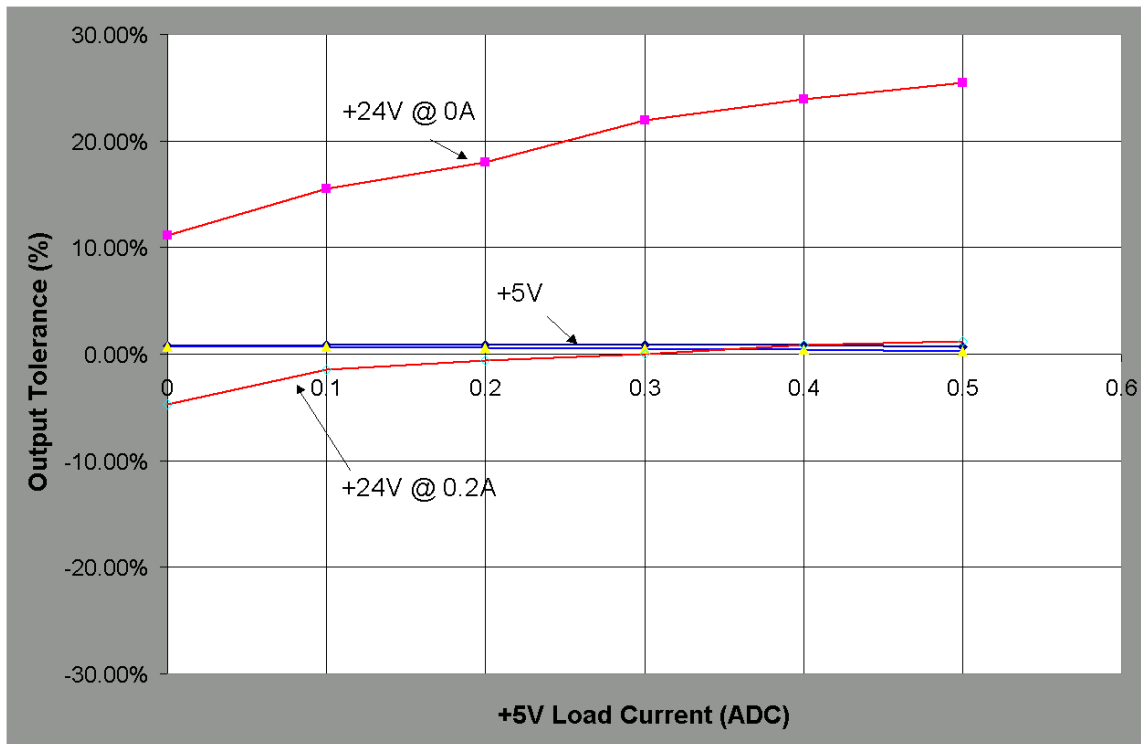

Figure 8 – Load Regulation @ 120VAC Input, Room Temperature



8.3.2 Line

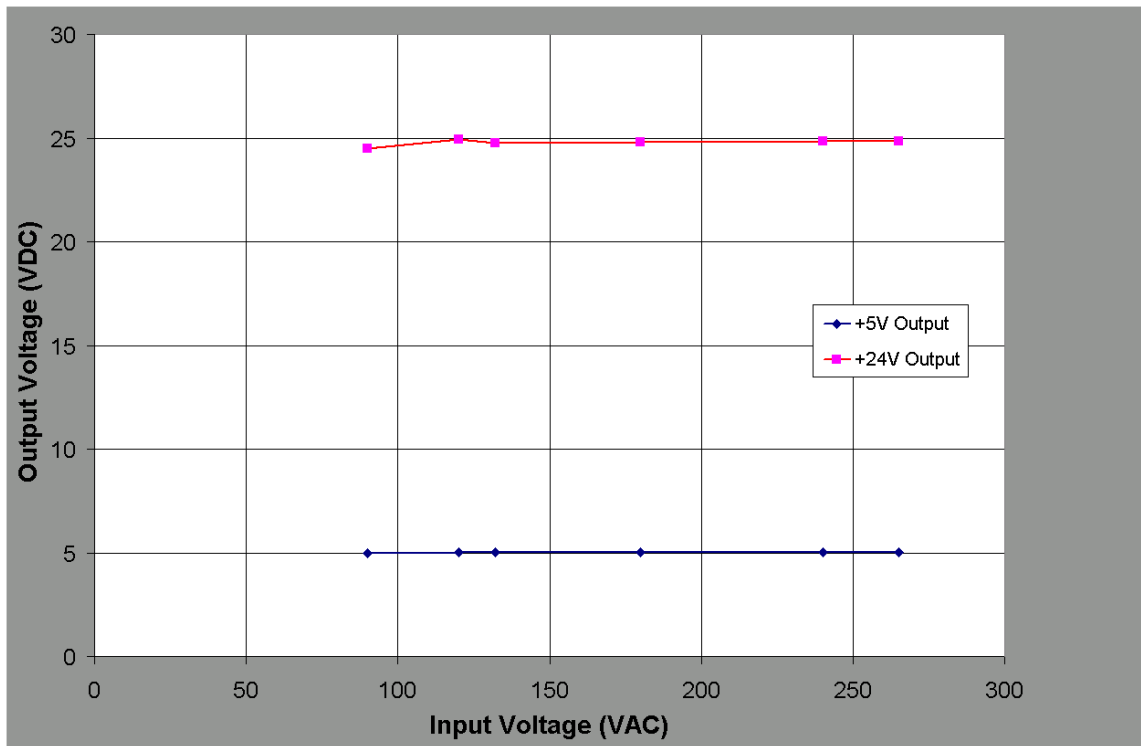

Figure 9 – Line Regulation, Room Temperature, Full Load



9 Waveforms

9.1 Drain Voltage and Current, Normal Operation

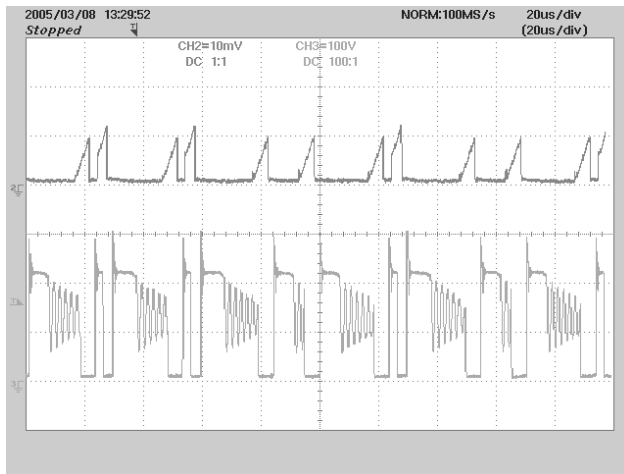

Figure 10 – 85 VAC, Full Load.
 Upper: I_{DRAIN} , 0.5 A / div
 Lower: V_{DRAIN} , 100 V, 2 μ s / div

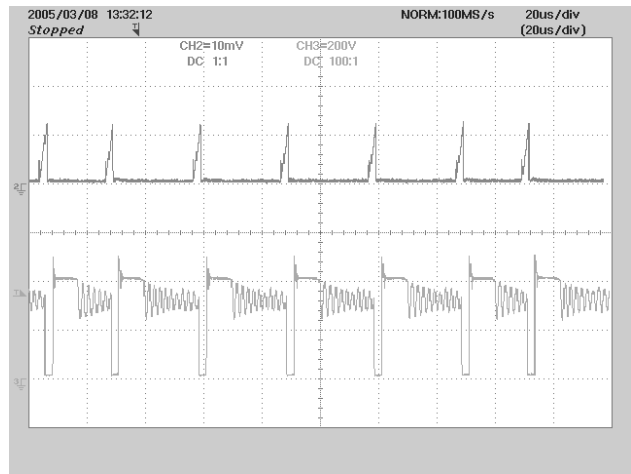

Figure 11 – 265 VAC, Full Load
 Upper: I_{DRAIN} , 0.5 A / div
 Lower: V_{DRAIN} , 200 V / div

9.2 Output Voltage Start-up Profile

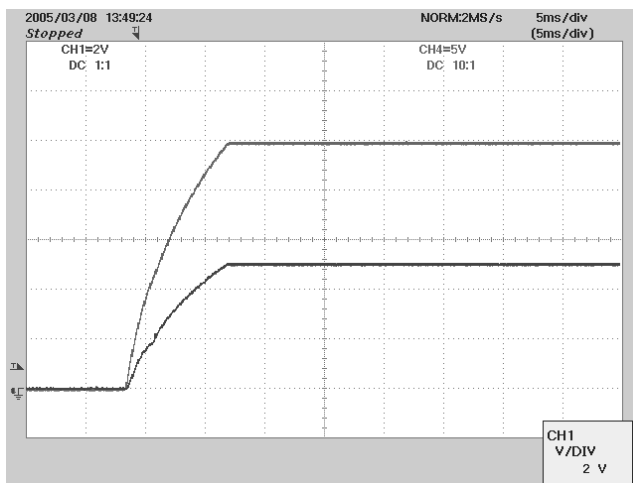

Figure 12 – Start-up Profile, 90 VAC
 5 ms / div.

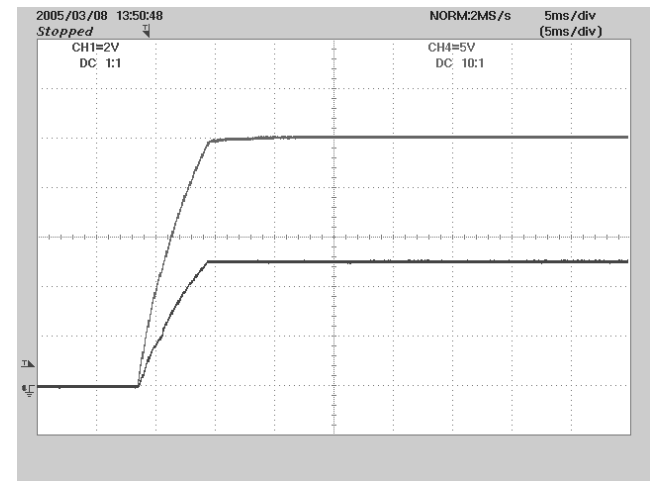

Figure 13 – Start-up Profile, 265 VAC
 5 ms / div.



9.3 Drain Voltage and Current Start-up Profile

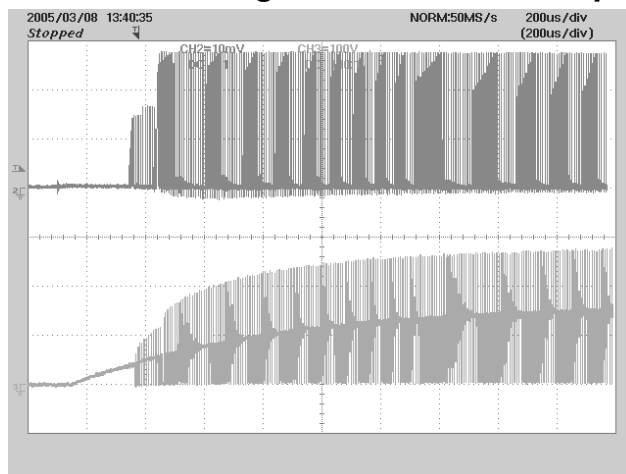

Figure 14 – 85 VAC Input and Maximum Load.
Upper: I_{DRAIN} , 0.5 A / div.
Lower: V_{DRAIN} , 100 V & 1 ms / div.

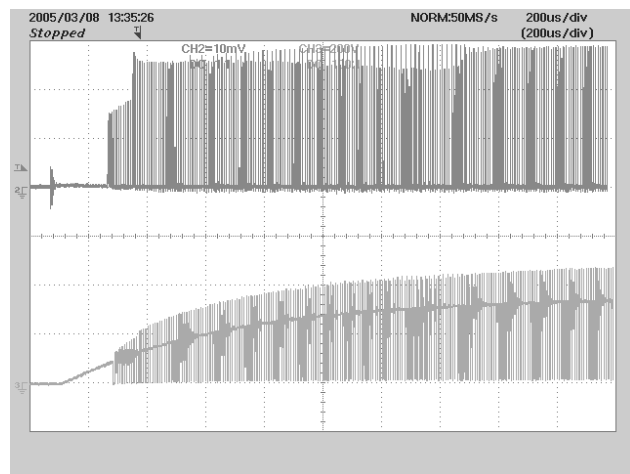

Figure 15 – 265 VAC Input and Maximum Load.
Upper: I_{DRAIN} , 0.5 A / div.
Lower: V_{DRAIN} , 200 V & 1 ms / div.

9.4 Load Transient Response (50% to 100% Load Step)

In the figures shown below, signal averaging was used to better enable viewing the load transient response. The oscilloscope was triggered using the load current step as a trigger source. Since the output switching and line frequency occur essentially at random with respect to the load transient, contributions to the output ripple from these sources will average out, leaving the contribution only from the load step response.

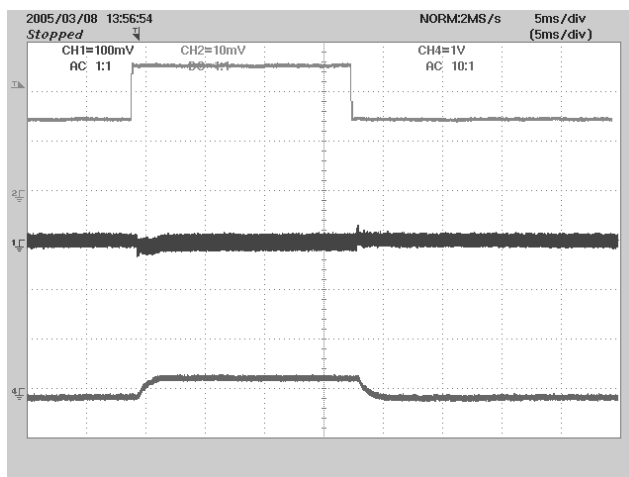

Figure 16 – Transient Response, 90 VAC, 75-100-75% Load Step.
Top: Load Current, 0.2 A/div.
Bottom: Output Voltage
50 mV, 5ms / div.

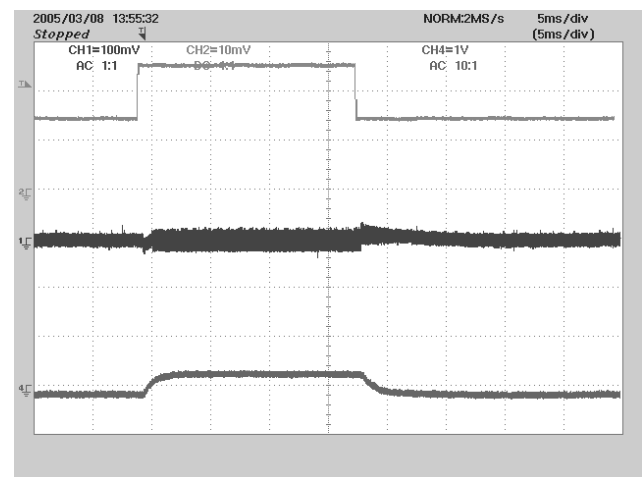

Figure 17 – Transient Response, 265 VAC, 75-100-75% Load Step
Upper: Load Current, 0.2 A / div.
Bottom: Output Voltage
50 mV, 5 ms / div.



9.5 Output Ripple Measurements

9.5.1 Ripple Measurement Technique

For DC output ripple measurements, a modified oscilloscope test probe must be utilized in order to reduce spurious signals due to pickup. Details of the probe modification are provided in Figure 18 and Figure 19.

The 5125BA probe adapter is affixed with two capacitors tied in parallel across the probe tip. The capacitors include one (1) 0.1 $\mu\text{F}/50\text{ V}$ ceramic type and one (1) 1.0 $\mu\text{F}/50\text{ V}$ aluminum electrolytic. **The aluminum electrolytic type capacitor is polarized, so proper polarity across DC outputs must be maintained (see below).**

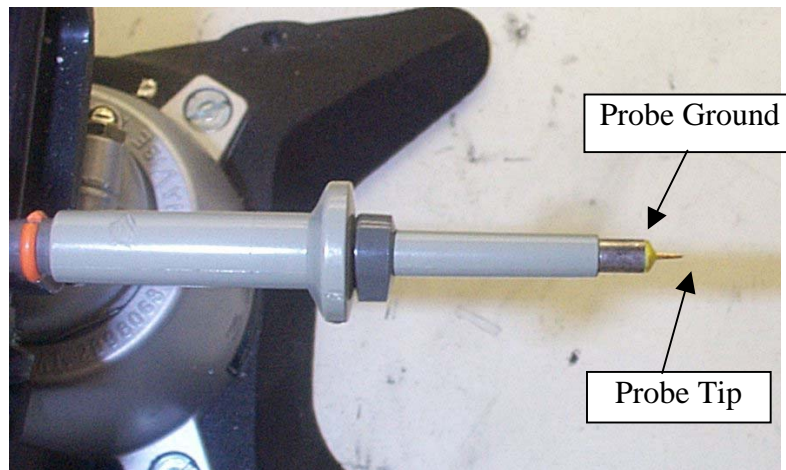

Figure 18 – Oscilloscope Probe Prepared for Ripple Measurement. (End Cap and Ground Lead Removed)



Figure 19 – Oscilloscope Probe with Probe Master 5125BA BNC Adapter. (Modified with wires for probe ground for ripple measurement, and two parallel decoupling capacitors added)

9.5.2 Measurement Results

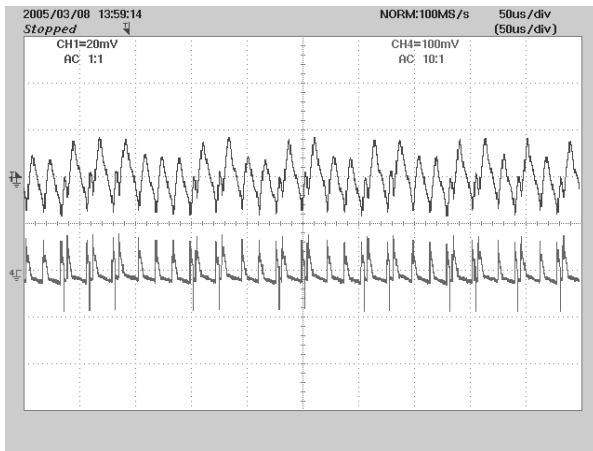

Figure 20 – Ripple, 90 VAC, Full Load.
50us

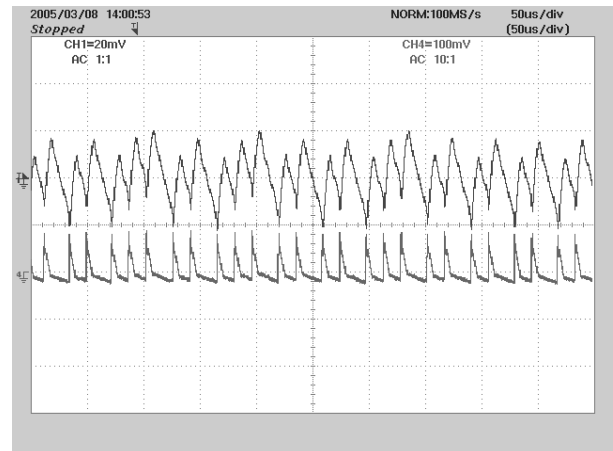

Figure 21 – Ripple, 265 VAC, Full Load.
50us



10 Conducted EMI

A conducted EMI scan of the prototype was taken to determine the effectiveness of the input pi-filter and transformer ESHIELD® construction. The following plots show the peak performance of the converter against quasi-peak (QP) and average (AVG) limits of EN55022 Class B. Both scans were taken at 120VAC/60Hz input with maximum load applied to the outputs. Since the peak scans are below the average limits, it is expected that the QP and Average scans would have greater than 10db of margin below the limits.

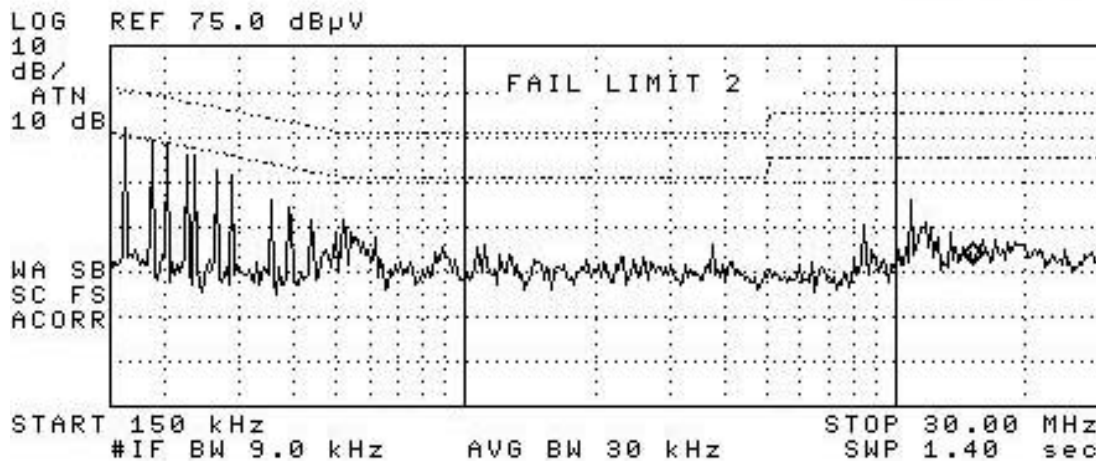

Figure 22 – Conducted EMI (LINE), Maximum Load, 120 VAC, 60 Hz, and EN55022 B Limits

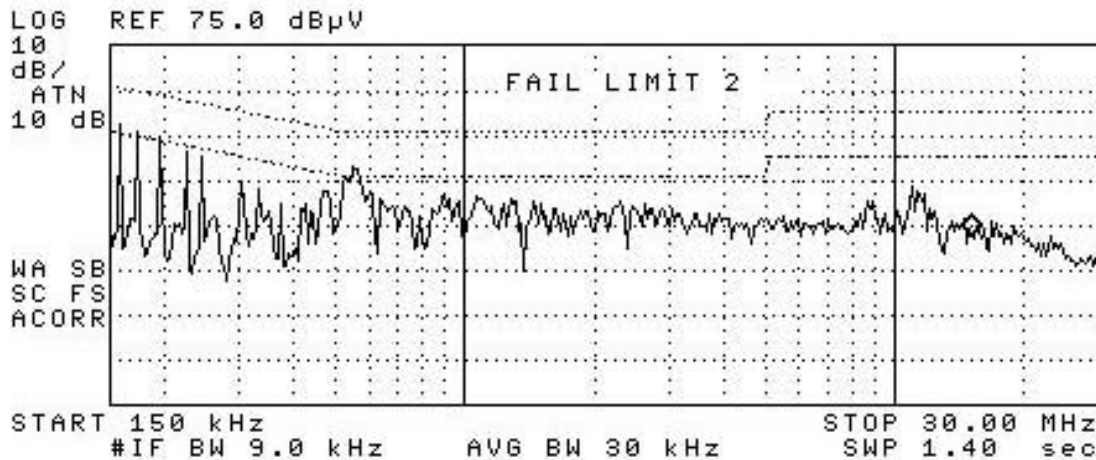

Figure 23 – Conducted EMI (Neutral), Maximum Load, 120 VAC, 60 Hz, and EN55022 B Limits



11 Revision History

Date	Author	Revision	Description & changes	Reviewed
10-26-05	RSP	1.0	Initial Release	KM/JC/VC



For the latest updates, visit our website: www.powerint.com

Power Integrations reserves the right to make changes to its products at any time to improve reliability or manufacturability. Power Integrations does not assume any liability arising from the use of any device or circuit described herein. POWER INTEGRATIONS MAKES NO WARRANTY HEREIN AND SPECIFICALLY DISCLAIMS ALL WARRANTIES INCLUDING, WITHOUT LIMITATION, THE IMPLIED WARRANTIES OF MERCHANTABILITY, FITNESS FOR A PARTICULAR PURPOSE, AND NON-INFRINGEMENT OF THIRD PARTY RIGHTS.

PATENT INFORMATION

The products and applications illustrated herein (including transformer construction and circuits external to the products) may be covered by one or more U.S. and foreign patents, or potentially by pending U.S. and foreign patent applications assigned to Power Integrations. A complete list of Power Integrations' patents may be found at www.powerint.com. Power Integrations grants its customers a license under certain patent rights as set forth at <http://www.powerint.com/ip.htm>.

The PI Logo, **TOPSwitch**, **TinySwitch**, **LinkSwitch**, **DPA-Switch**, **EcoSmart**, **PI Expert** and **PI FACTS** are trademarks of Power Integrations, Inc. Other trademarks are property of their respective companies. ©Copyright 2005 Power Integrations, Inc.

Power Integrations Worldwide Sales Support Locations

WORLD HEADQUARTERS

5245 Hellyer Avenue
San Jose, CA 95138, USA.
Main: +1-408-414-9200
Customer Service:
Phone: +1-408-414-9665
Fax: +1-408-414-9765
e-mail: usasales@powerint.com

GERMANY

Rueckertstrasse 3
D-80336, Munich
Germany
Phone: +49-89-5527-3910
Fax: +49-89-5527-3920
e-mail: eurosales@powerint.com

JAPAN

Keihin Tatemono 1st Bldg
2-12-20
Shin-Yokohama, Kohoku-ku,
Yokohama-shi, Kanagawa ken,
Japan 222-0033
Phone: +81-45-471-1021
Fax: +81-45-471-3717
*e-mail:
japansales@powerint.com*

TAIWAN

5F, No. 318, Nei Hu Rd., Sec. 1
Nei Hu Dist.
Taipei, Taiwan 114, R.O.C.
Phone: +886-2-2659-4570
Fax: +886-2-2659-4550
*e-mail:
taiwansales@powerint.com*

CHINA (SHANGHAI)

Rm 807-808A,
Pacheer Commercial Centre,
555 Nanjing Rd. West
Shanghai, P.R.C. 200041
Phone: +86-21-6215-5548
Fax: +86-21-6215-2468
e-mail: chinasales@powerint.com

INDIA

261/A, Ground Floor
7th Main, 17th Cross,
Sadashivanagar
Bangalore, India 560080
Phone: +91-80-5113-8020
Fax: +91-80-5113-8023
e-mail: indiasales@powerint.com

KOREA

RM 602, 6FL
Korea City Air Terminal B/D,
159-6
Samsung-Dong, Kangnam-Gu,
Seoul, 135-728, Korea
Phone: +82-2-2016-6610
Fax: +82-2-2016-6630
*e-mail:
koreasales@powerint.com*

EUROPE HQ

1st Floor, St. James's House
East Street, Farnham
Surrey, GU9 7TJ
United Kingdom
Phone: +44 (0) 1252-730-140
Fax: +44 (0) 1252-727-689
e-mail: eurosales@powerint.com

CHINA (SHENZHEN)

Room 2206-2207, Block A,
Elec. Sci. Tech. Bldg.
2070 Shennan Zhong Rd.
Shenzhen, Guangdong,
China, 518031
Phone: +86-755-8379-3243
Fax: +86-755-8379-5828
e-mail: chinasales@powerint.com

ITALY

Via Vittorio Veneto 12
20091 Bresso MI
Italy
Phone: +39-028-928-6000
Fax: +39-028-928-6009
e-mail: eurosales@powerint.com

SINGAPORE

51 Newton Road,
#15-08/10 Goldhill Plaza,
Singapore, 308900
Phone: +65-6358-2160
Fax: +65-6358-2015
*e-mail:
singaporesales@powerint.com*

APPLICATIONS HOTLINE

World Wide +1-408-414-9660

APPLICATIONS FAX

World Wide +1-408-414-9760

